

Principle drawing of a time distribution system

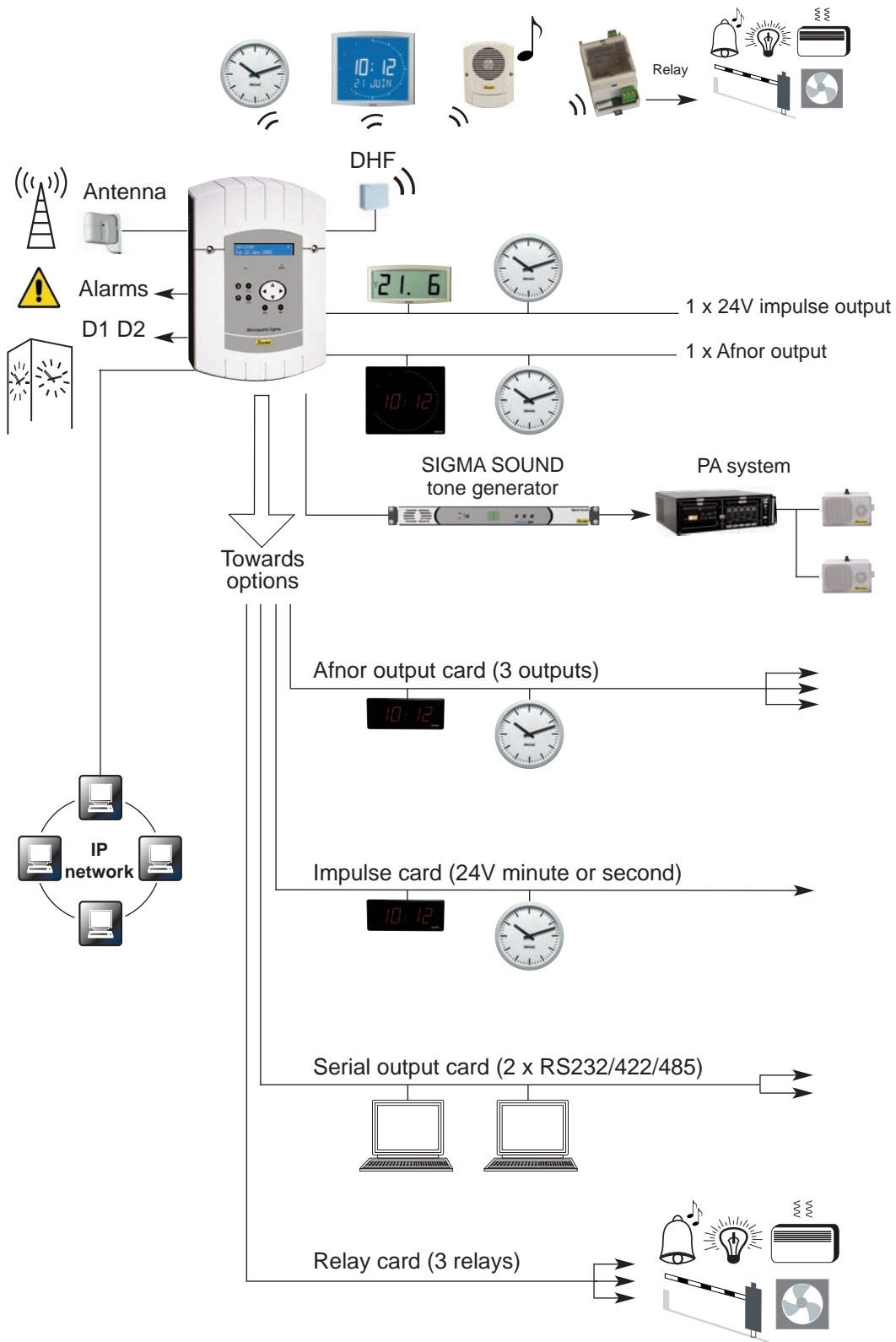

Dimensions in mm

SIGMA - wall mounted



SIGMA - rack

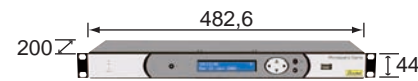

Accessories :

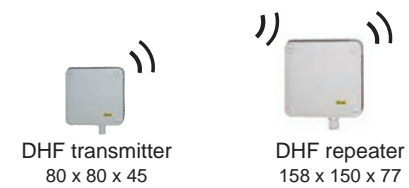

Relay controller DHF

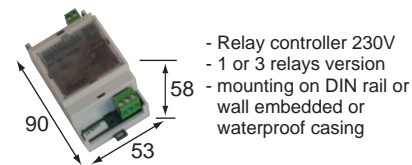

- Relay controller 230V
- 1 or 3 relays version
- mounting on DIN rail or wall embedded or waterproof casing

Melodys DHF Wireless bell system



- Powerful carillon: 90 dB
- Wire or wireless version
- 16 melodies

SIGMA



Master Clock

Time distribution & time scheduling
Energy management

Technical features

- Power: 110/230V or TBT 24V
- Time base accuracy: 0,1 sec/day
- 3 x relays for D1D2 impulses, alarms or circuit programming
- 1 x dry contact input

- Integrated protection of the output against short circuits and overload
- Fast adjustment of clock after power cut
- Permanent saving of settings.

Spinnaker: 02 41 56 06 35



B.P. 1
49340 Trémentines
FRANCE

Tel + 33 2 41 71 72 00
Fax +33 2 41 71 72 02
www.bodet.com



Technical features and aesthetical aspects are subject to change without notice



REF: 653071 C/0609



The **MIC SIGMA** is upgradeable and modular to match various installation requirements such as Schools, Industries, Hospitals, Administration buildings, Railway stations, Airports...

A reliable and accurate time reference for computer network's and synchronisation with its internal astronomical timer, the SIGMA can optimise energy saving, providing an accurate control of lighting, heating, air conditioning systems...



SIGMA

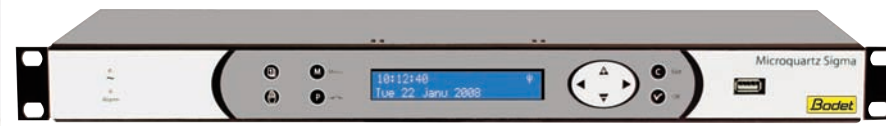

Programming through PC software and data transferring via USB key or IP network

PC programming software

- Simple and user friendly
- All functions and programming accessible and downloadable

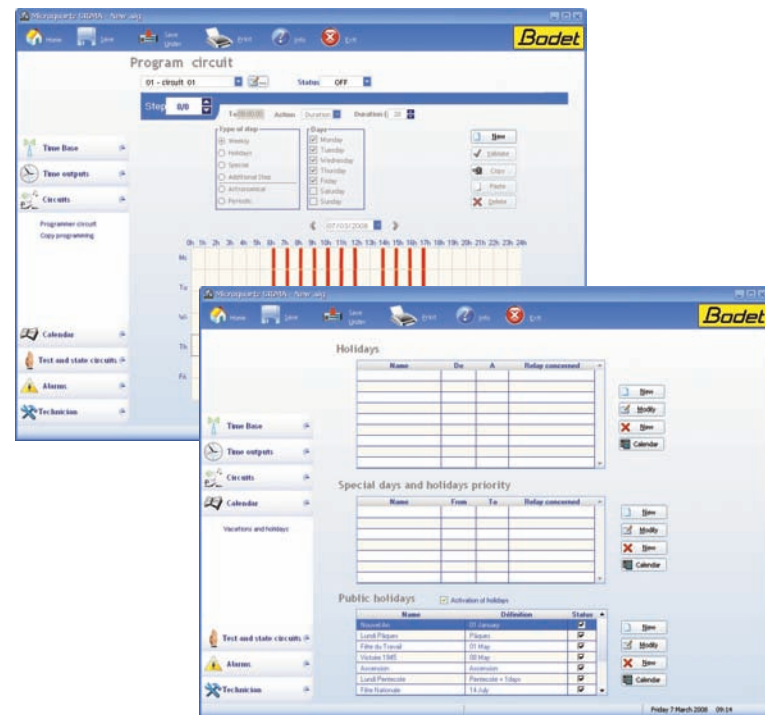

Display with 2 lines of 24 luminous characters

Circuit 01 : START ok

Dates : Holidays
12/02 → 25/02 SELECT ok

User-friendly and simple interface

- Programming, manual or automatic activation of the relays
- Programming of holidays or special day periods and summer/winter setting
- Programming of the time signal on the output
- Display of programming and alarms

Main benefits

- The SIGMA is an upgradeable product
- Wireless (DHF) and wired time distribution
- NTP (Network Time Protocol) server (SIGMA MOD)
- Programming and setting through PC WINDOWS software and USB key
- Circuit programming in various modes: weekly, bank day, holidays, and special days, astronomic or periodic
- Circuit controlled through wireless or wired connection

Main applications



Schools



Hospitals



Industrial buildings



Railway stations



Airports



Administration buildings, offices



Food and pharmaceutical industries



3 models

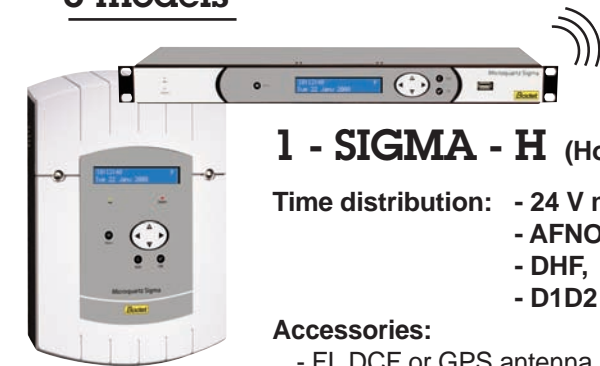

1 - SIGMA - H (Hour)

Time distribution: - 24 V minute/second impuls 0,5A,
- AFNOR,
- DHF,
- D1D2 230V (tower clock).

Accessories:

- FI, DCF or GPS antenna
- Wireless transmitter or repeater

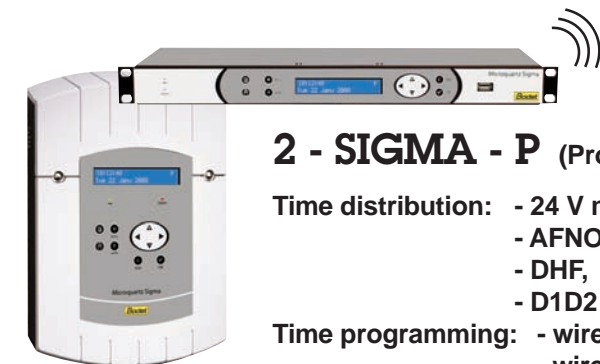

2 - SIGMA - P (Programmer)

Time distribution: - 24 V minute/second impuls 1A,
- AFNOR,
- DHF,
- D1D2 230V (tower clock).

Time programming: - wired relays,
- wireless bell and relay systems.

Accessories:

- FI, DCF or GPS radio antenna
- Wireless transmitter or repeater
- Wireless relay controller, Wireless carillon MELODYS
- SIGMA SOUND tone generator for PA system
- Possibility to add 2 option cards

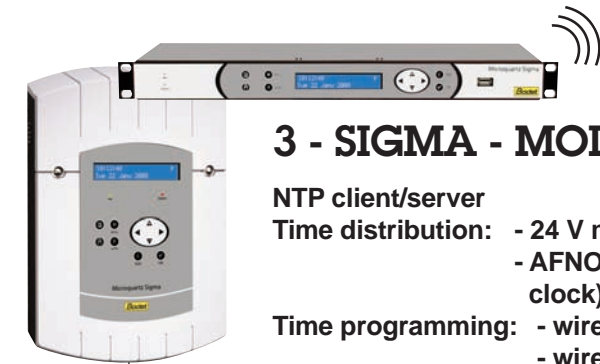

3 - SIGMA - MOD (Modular)

NTP client/server

Time distribution: - 24 V minute/second impuls 0,5A,
- AFNOR, DHF, D1D2 230V (tower clock),

Time programming: - wired relays,
- wireless bell and relay systems.

Accessories:

- FI, DCF or GPS antenna
- Wireless transmitter or repeater
- Wireless relay controller
- Wireless bell system (Melodys)
- SIGMA SOUND tone generator for PA system
- Possibility to add option cards (2 on wall model, 4 on rack model).

Option cards:

- Afnor output card (3 outputs), serial output card (2 outputs)
- 24V minute/ second impulse card: 0,5A
- Relay card: 3 relays

